

RINAGYM

KIDS

WALL BAR SET

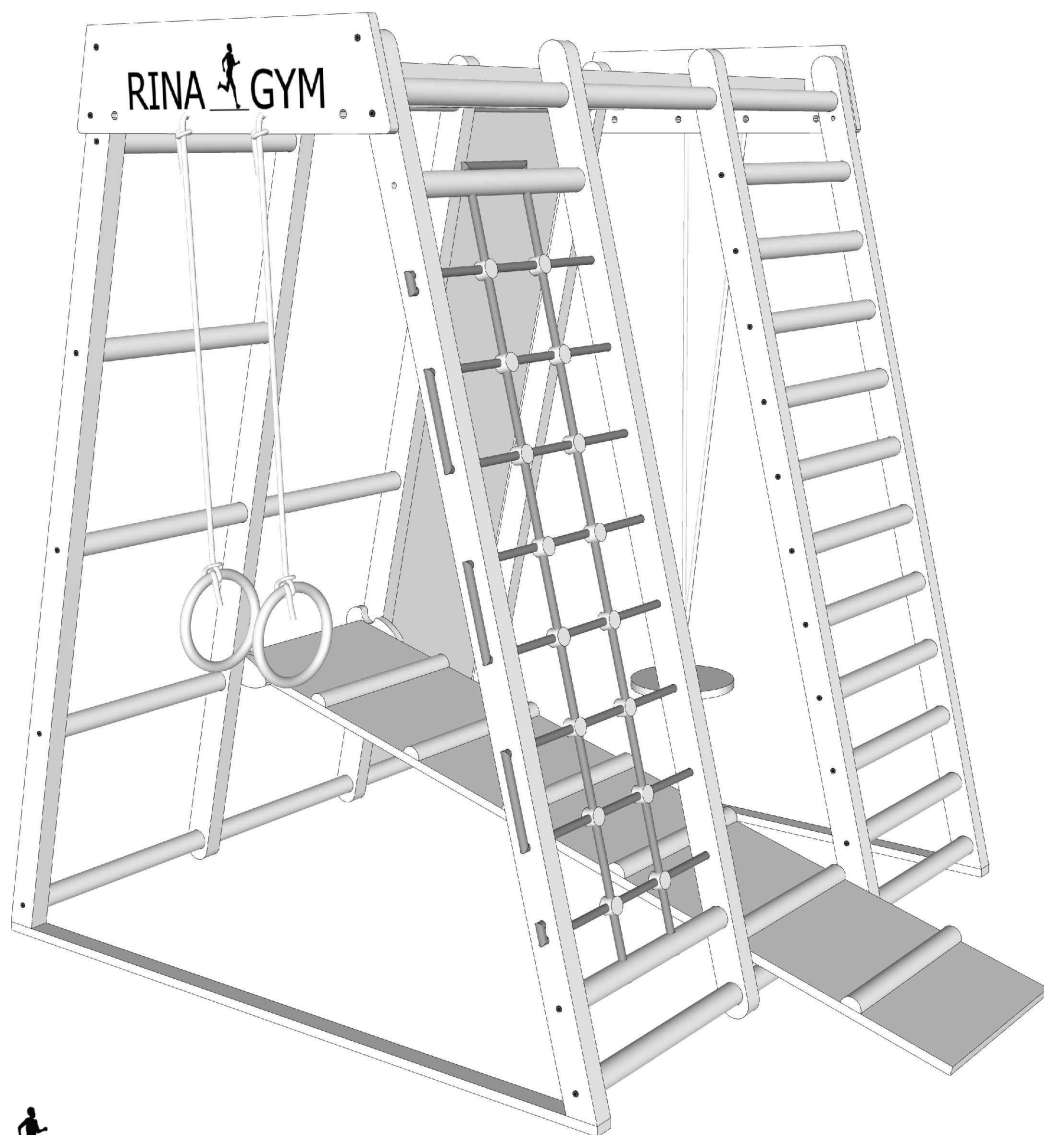

RINA GYM
Children's sports complex

EN Attention!

If you have damaged any parts while assembling the product, please send us an email with a detailed description of the problem (if it possible – with photos). We will send replacement parts

PL Uwaga!

Jeśli podczas montażu produktu uszkodzisz jakiegokolwiek części, prześlij nam maila ze szczegółowym opisem problemu (jeśli to możliwe – ze zdjęciami). Wyślemy części zamienne.

DE Achtung!

Falls bei der Zusammensetzung des Produktes einige Teile beschädigt wurden, senden Sie uns bitte eine E-Mail mit detaillierten Beschreibung des Problems (falls möglich - mit Fotos). Wir senden Ihnen die entsprechenden Ersatzteile zu.

If the product swings without user intervention, try the following: loose the 8 nuts at the top of the playground, then sway it on a smooth surface (rocking should stop) and tighten the 8 nuts again.

Jeśli konstrukcja buja się bez obciążenia to delikatnie poluzuj 8 śrub w górnej części konstrukcji, następnie połóż konstrukcję na płaskiej powierzchni, tak aby całość przestała się chwiać, następnie dokręć ponownie 8 śrub.

Falls das Produkt ohne Eingreifen des Benutzers schaukelt, versuchen Sie Folgendes: Lösen Sie die 8 Muttern oben am Deck, schaukeln Sie dann das Deck auf einer glatten Oberfläche bis es zur einem Stillstand kommt und ziehen Sie die 8 Muttern wieder fest.

RINAGYM KIDS WALL BAR SET



Age group (years), 1+
Dla dzieci powyżej 1 roku życia
Für Kinder ab 1 Jahr



Weight (gross): 35 kg
Waga produktu: 35 kg
Produktgewicht: 35 kg



Load on attachments: 40 kg
Maks. ciężar zawieszenia: 40 kg
Maximales Aufhängungsgewicht: 40 kg



Area: 1200 x 1200 mm
Powierzchnia: 1200 x 1200 mm
Oberfläche: 1200 x 1200 mm



Permissible load: 60 kg
Maks. obciążenie: 60 kg
Maximale Belastung: 60 kg



Wysokość: 1445 mm
Height: 1445 mm
Höhe: 1445 mm



Do not use a drill in this product!
Nie używaj wiertarki w tym produkcie!
Verwenden Sie bitte keine Bohrmaschine!



Service life: 5 years
Serwis: 5 lat
Dienst: 5 Jahre

EN Attention!

- Children's sports complex is designed for personal use indoors.
- During the assembly process, all the assemblies and fasteners are not tightened to the end, only after complete assembly, all connections are checked and tightened.
- Be sure to check the safety and reliability of attachment of mounted elements at least 1 time in 10 days.
- It is recommended to place a mat with a minimum thickness of 40 mm around the perimeter.
- It is not recommended to allow children to study without supervision of adults!
- Before installation in the working position, store in the packaging of the manufacturer in closed dry rooms with natural air ventilation.
- Because of the natural materials, it should not be exposed to adverse weather conditions such as rain, snow or water.

The warranty period of the product is 24 months from the date of sale, but not more than 30 months from the date of manufacture.

The complex does not contain substances hazardous to health and life.

PL Uwaga!

- Kompleks sportowy dla dzieci, przeznaczony jest do użytku osobistego w pomieszczeniach.
- Podczas procesu montażu wszystkie elementy nie są skręcone do końca, dopiero po całkowitym montażu urządzenie jest gotowe do zabawy.
- Pamiętaj, aby cyklicznie (co najmniej 1 raz na 10 dni) sprawdzać bezpieczeństwo i niezawodność wszystkich elementów.
- Zaleca się umieszczenie maty wokół urządzenia o minimalnej grubości 40 mm.
- Nie zaleca się, aby dzieci bawiły się bez nadzoru dorosłych!
- Przed montażem, urządzenie należy przechowywać w oryginalnym opakowaniu w zamkniętych, suchych pomieszczeniach z wentylacją naturalną.
- Ze względu na naturalne materiały, nie należy narażać go na niekorzystne warunki pogodowe, takie jak deszcz, śnieg lub woda.

Okres gwarancji na produkt wynosi 24 miesiące od daty sprzedaży, ale nie więcej niż 30 miesięcy od daty produkcji.

Urządzenie nie zawiera substancji niebezpiecznych dla zdrowia i życia.

DE Achtung!

- Die Kindersportanlage ist für die individuelle Indoor-Nutzung konzipiert.
- Während der Montage sollen alle Befestigungselemente nicht bis zum Ende angezogen werden, erst nach vollständiger Montage werden alle Verbindungen überprüft und endgültig nachgezogen.
- Stellen sicher, dass die Sicherheit und Zuverlässigkeit der Befestigung der montierten Elemente mindestens 1 Mal in 10 Tagen überprüft wird.
- Es ist zu empfehlen, während der Sportübungen eine Matte mit mindestens 40 mm Stärke auf dem Fußboden unter dem KOMPLEX zu benutzen.
- Die Kinder dürfen nur unter der Aufsicht von Erwachsenen spielen!
- Vor der Montage soll das Produkt in der Verpackung des Herstellers in einem geschlossenen, dunklen Raum mit natürlicher Belüftung gelagert werden.
- Aufgrund der natürlichen Materialien sollte es keinen ungünstigen Wetterbedingungen wie Regen, Schnee oder Wasser ausgesetzt werden.

Die Garantiefrist für die Nutzung des Produktes beträgt 24 Monate ab dem Verkaufstag, jedoch nicht mehr als 30 Monate ab dem Herstellungsdatum.

Die Anlage enthält keine für die Gesundheit und das Leben gefährlichen Stoffe.

ITEMS AKCESORIA ZUBEHÖR



2x
2023-003

L:4700 mm



1x
2023-001

L:2700 mm



1x
2023-002

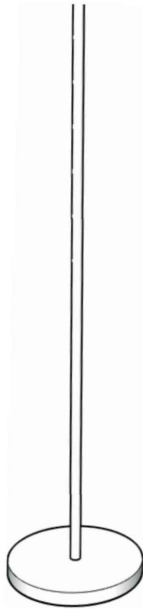

1x
2023-004

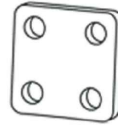

3x
2023-007

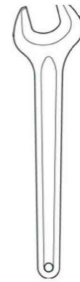

1x
2023-008

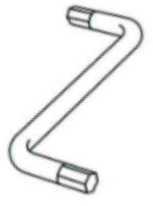

1x
2023-009

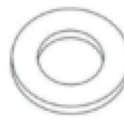

8x
2023-010

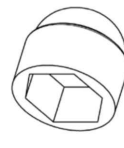

8x
2023-011

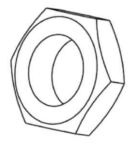

8x
2023-012



2x
2023-005

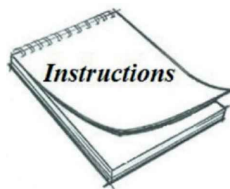

1x
2023-006



8x
2023-013



24x
2023-014

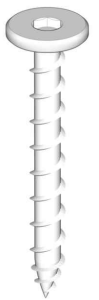

64x
2023-015



16x
2023-016



16x
2023-017



2x
2023-018-1

+



2x
2023-018-2



6x
2023-019



+



12x
2023-020-1

12x
2023-020-2

ITEMS AKCESORIA ZUBEHÖR

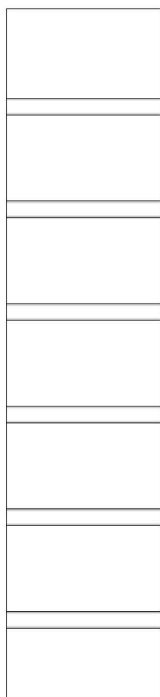

1x
2023-036

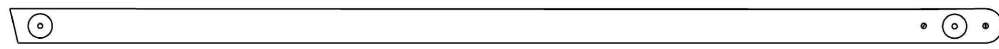

1x
2023-021

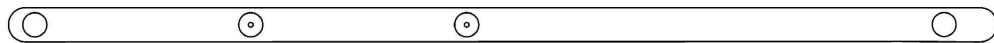

1x
2023-022

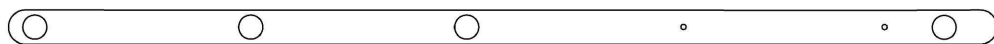

1x
2023-023



1x
2023-024

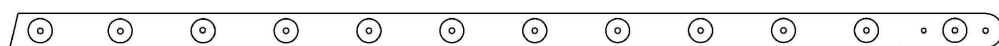

1x
2023-025

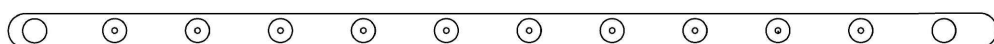

1x
2023-026

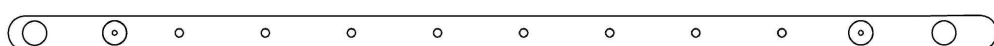

1x
2023-027



1x
2023-028

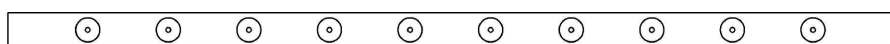

2x
2023-029



2x
2023-030



2x
2023-031



2x
2023-032



2x
2023-033

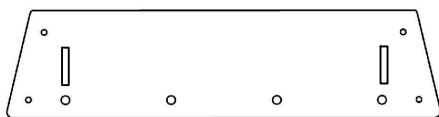

1x
2022-038



22x
2023-034



2x
2023-035

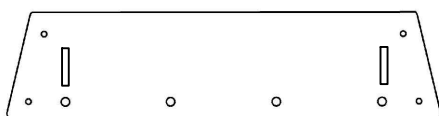

1x
2022-039

1x
2023-037





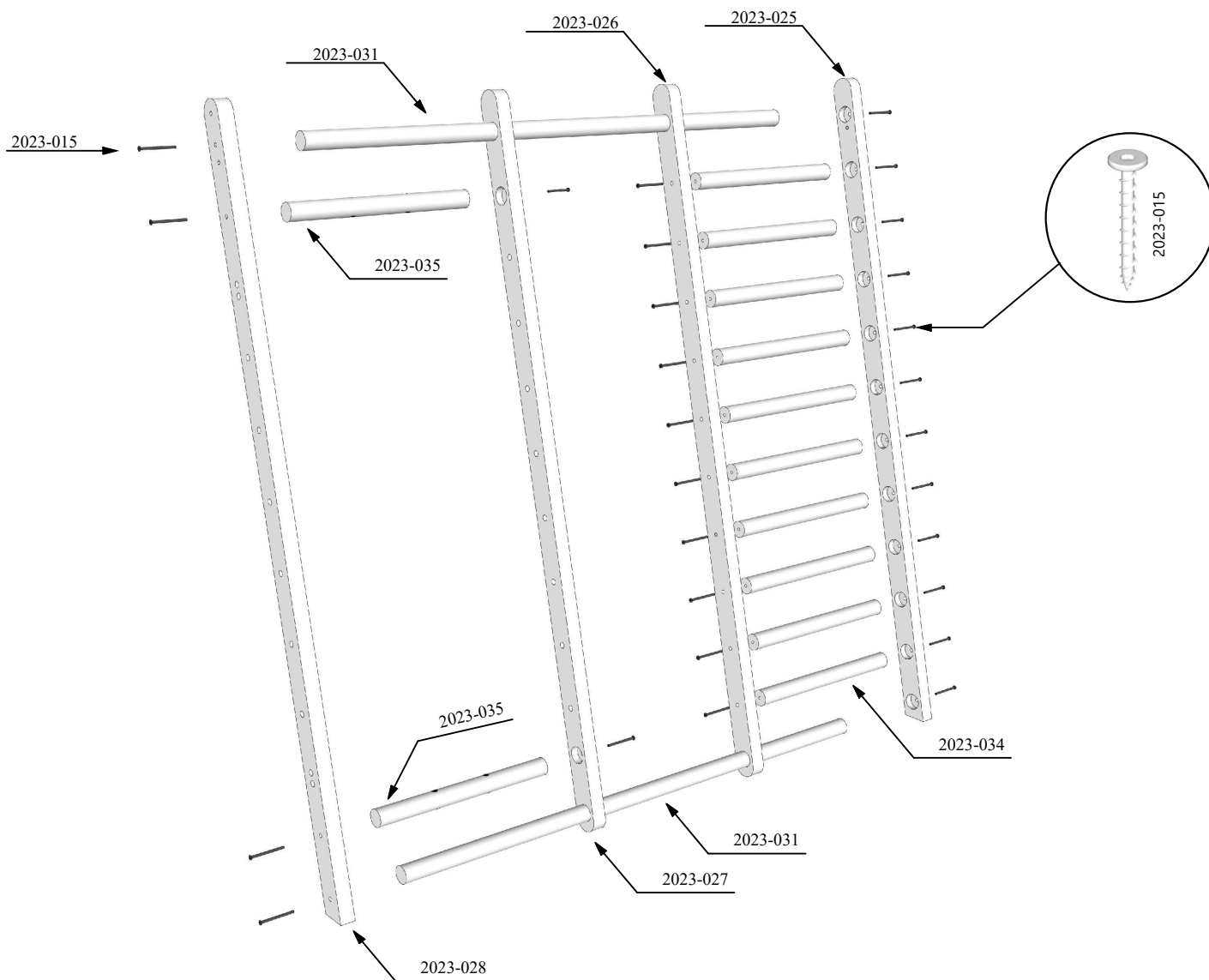

ASSEMBLY MONTAŽ INSTALLATION

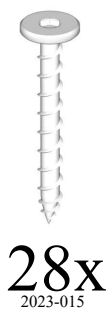
STEP • KROK • DER SCHRITT
1



ITEMS LIST / POTRZEDMIOTY / BENOTIGTE ARTIKEL



	1x 2023-025
	1x 2023-026
	1x 2023-027
	1x 2023-028
	2x 2023-031
	2x 2023-035
	10x 2023-034

RINAGYM KIDS
WALL BAR SET

ASSEMBLY MONTAŽ INSTALLATION

STEP • KROK • DER SCHRITT
2

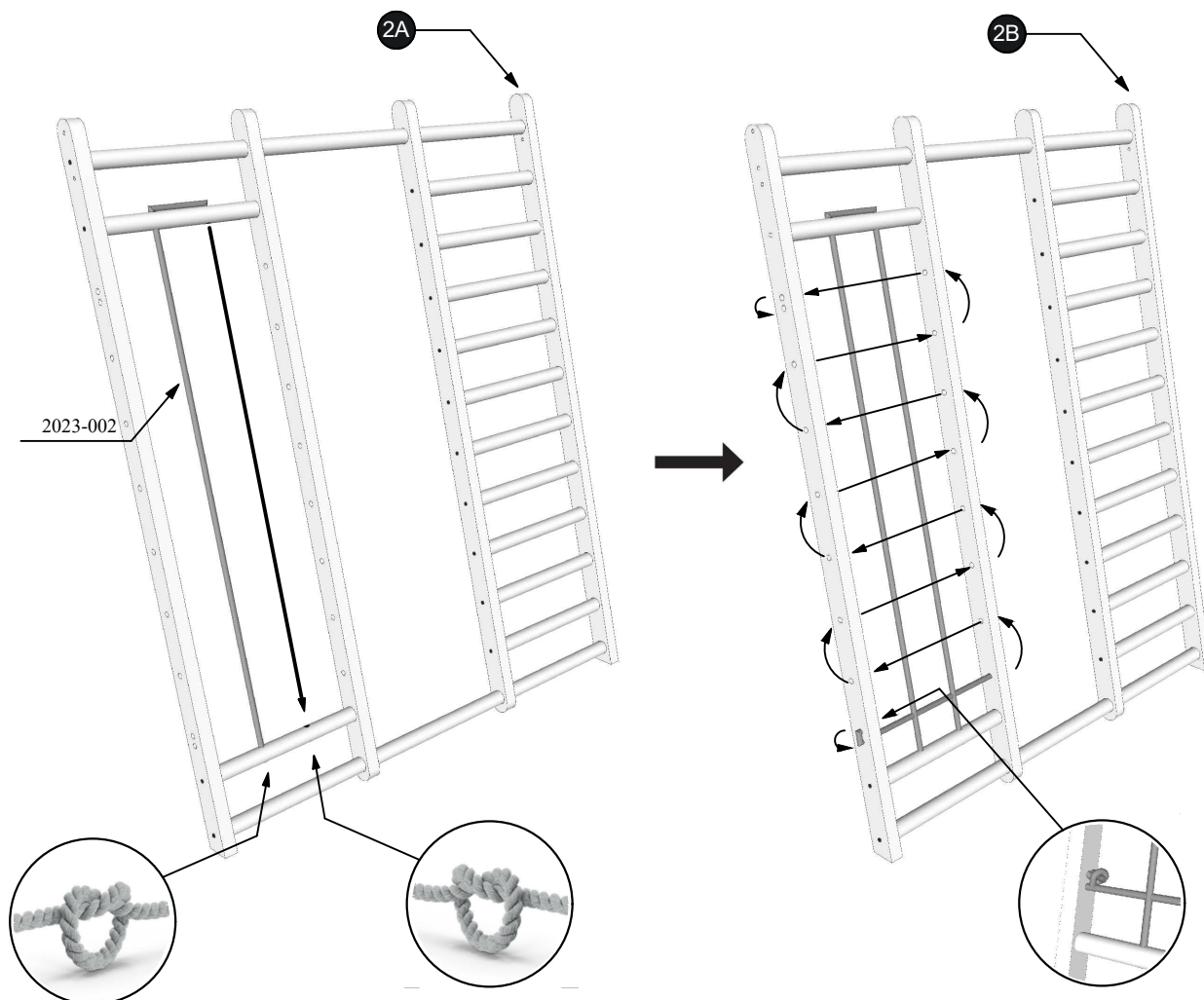

ITEMS LIST / POTRZEDMIOTY / BENÖTIGTE APTIKEL

L:2700 mm



2023-002

1x

L:4700 mm



2023-001

1x

RINAGYM KIDS
WALL BAR SET

ASSEMBLY MONTAŽ INSTALLATION

STEP • KROK • DER SCHRITT
3

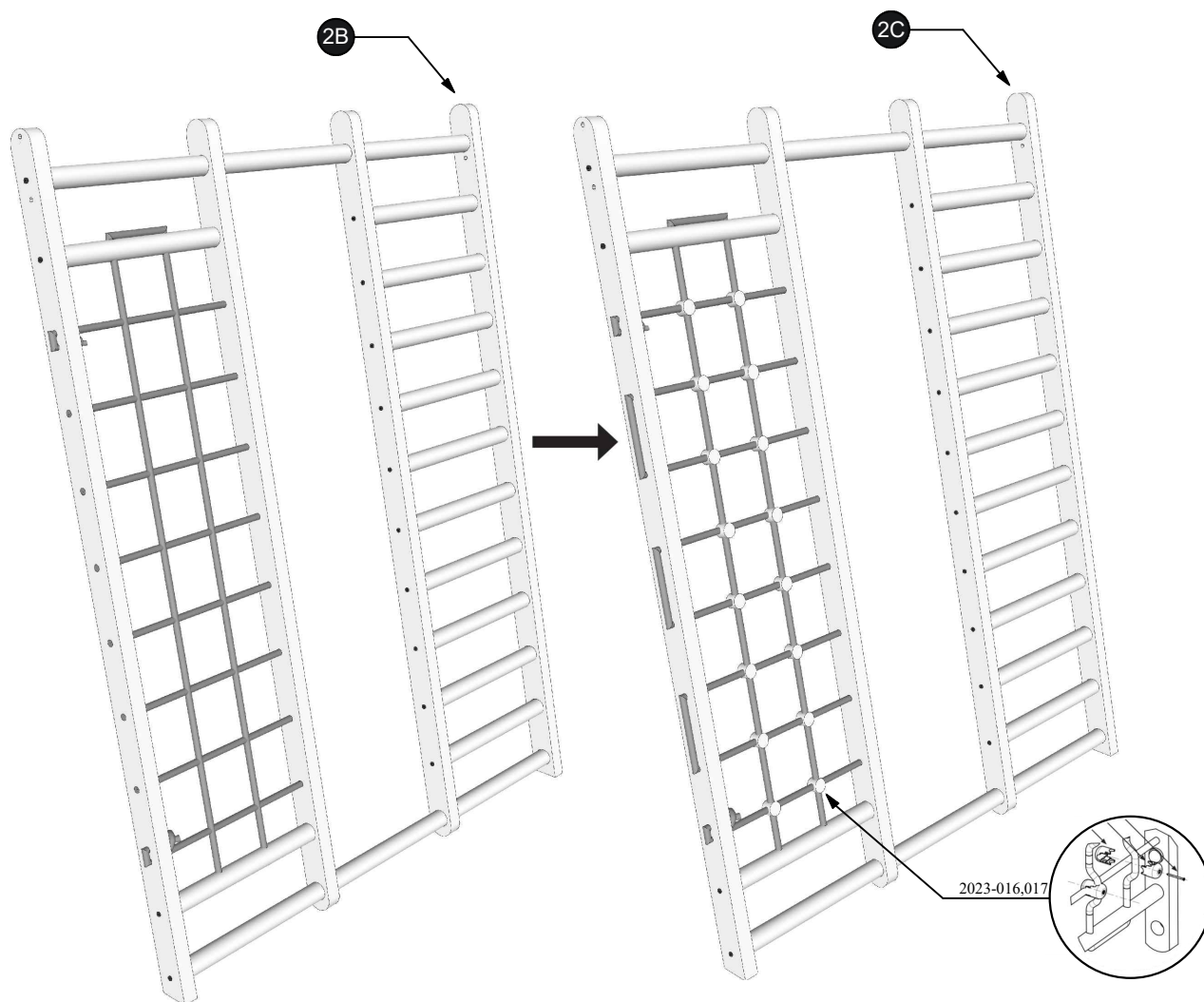

ITEMS LIST / POTRZEDMIOTY / BENÖTIGTE ARTIKEL



16x
2023-016



16x
2023-017



16x
2023-014

RINAGYM KIDS
WALL BAR SET

ASSEMBLY MONTAŻ INSTALLATION

STEP • KROK • DER SCHRITT
4

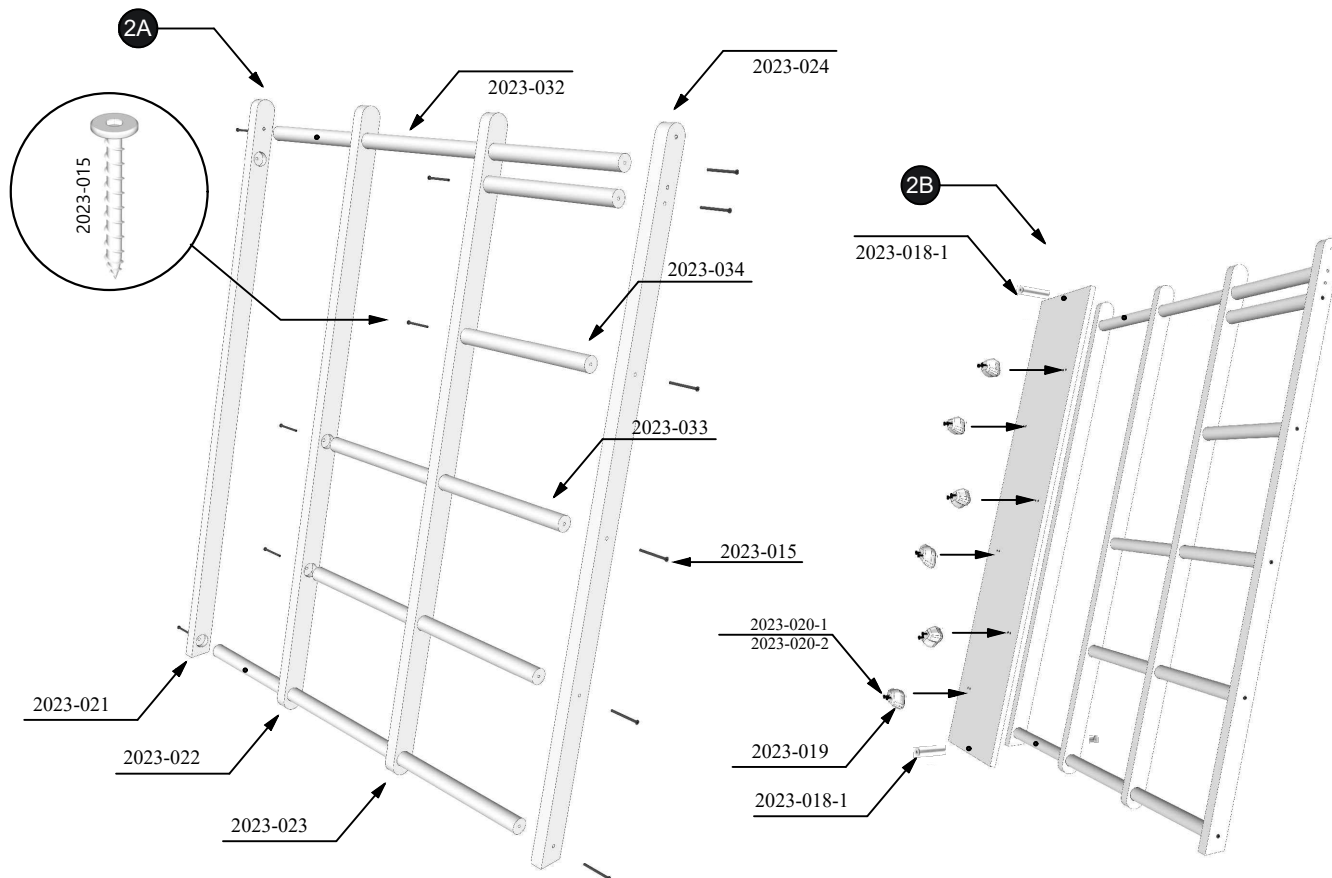

ITEMS LIST / POTRZEDMIOTY / BENÖTIGTE ARTIKEL



2x
2023-018-1



2x
2023-018-2



12x
2023-015



12x
2023-020-1



12x
2023-020-2



6x
2023-019



1x
2023-021

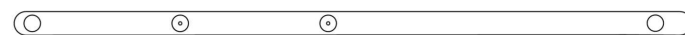

1x
2023-022



1x
2023-023



1x
2023-024



2x
2023-032



2x
2023-033



2x
2023-034

RINAGYM KIDS
WALL BAR SET

ASSEMBLY MONTAŽ INSTALLATION

STEP • KROK • DER SCHRITT
5

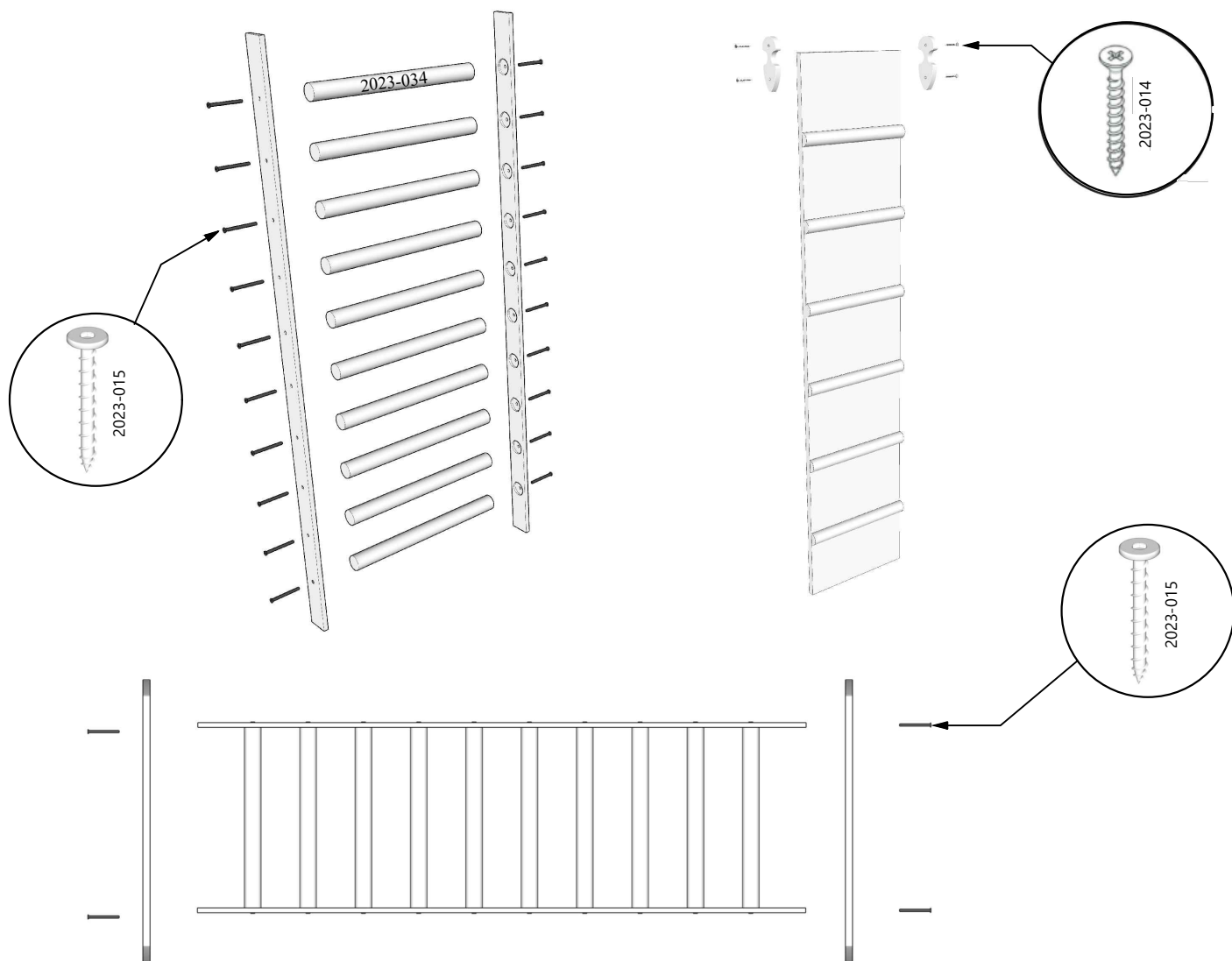

ITEMS LIST / POTRZEDMIOTY / BENOTIGTE APTIKEL



4x
2023-014

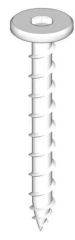

24x
2023-015

1x
2023-038

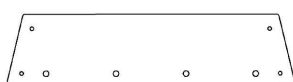

1x
2023-039

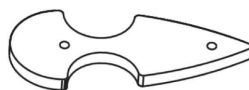

2x
2023-005

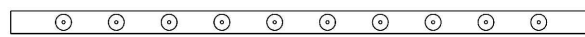

2x
2023-035



10x
2023-034



1x
2023-036

RINAGYM KIDS
WALL BAR SET

10

ASSEMBLY MONTAŻ INSTALLATION

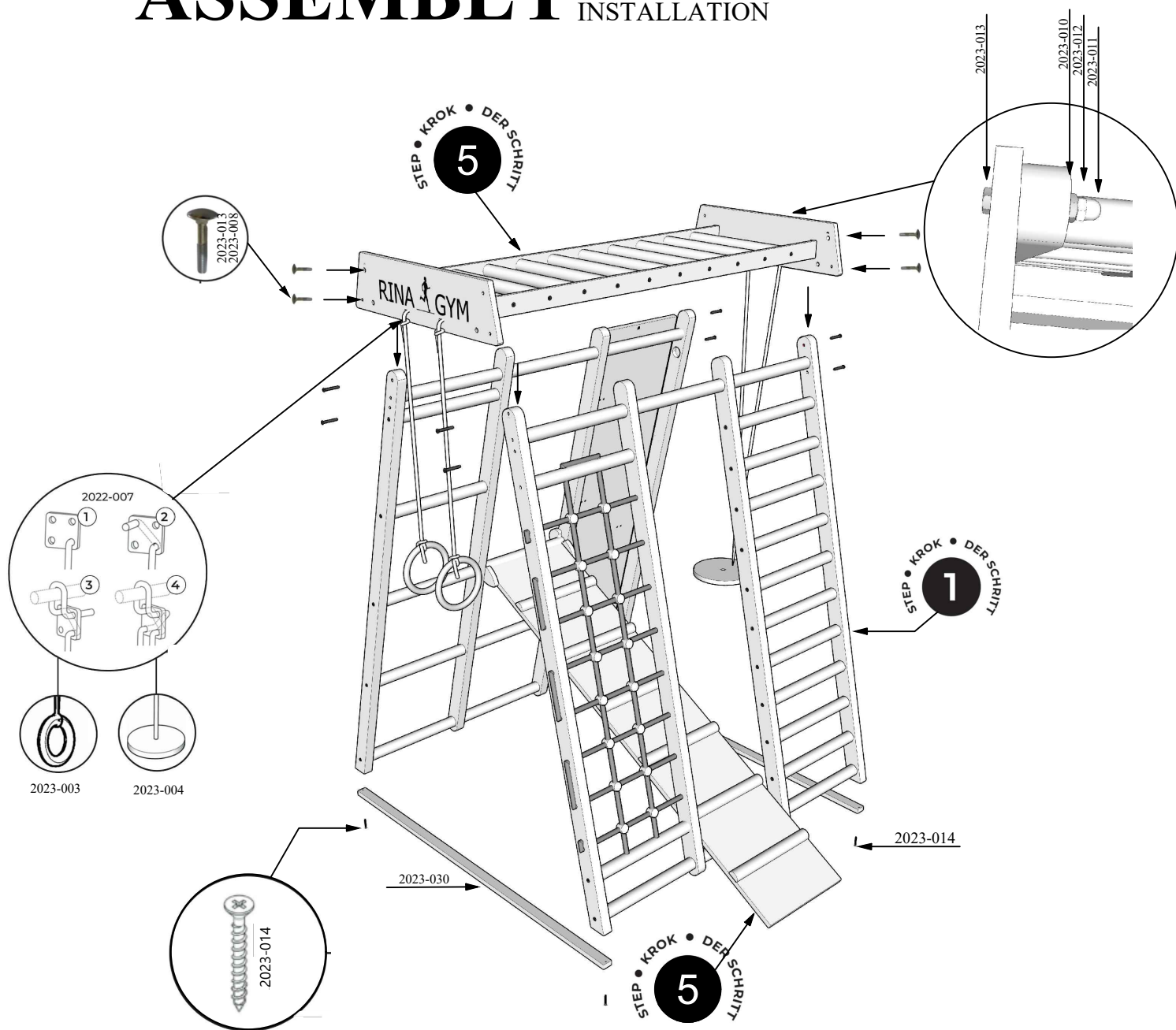

ITEMS LIST / POTRZEDMIOTY / BENOTIGTE APTIKEL

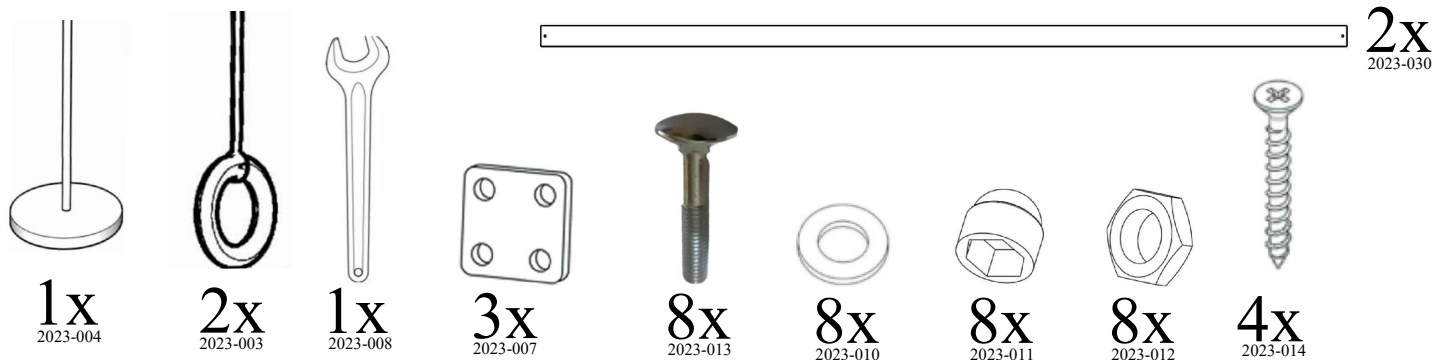

RINAGYM KIDS WALL BAR SET